



HAL
open science

Distributed Physical-layer Network Coding MAC Protocol

Mohammed Aissaoui, Chiraz Houaidia, Adrien van den Bossche, Thierry Val,
Leila Azouz Saidane

► **To cite this version:**

Mohammed Aissaoui, Chiraz Houaidia, Adrien van den Bossche, Thierry Val, Leila Azouz Saidane. Distributed Physical-layer Network Coding MAC Protocol. *Ad Hoc Networks*, inPress, 153, pp.1-30. 10.1016/j.adhoc.2023.103344 . hal-04265222

HAL Id: hal-04265222

<https://univ-tlse2.hal.science/hal-04265222>

Submitted on 30 Oct 2023

HAL is a multi-disciplinary open access archive for the deposit and dissemination of scientific research documents, whether they are published or not. The documents may come from teaching and research institutions in France or abroad, or from public or private research centers.

L'archive ouverte pluridisciplinaire **HAL**, est destinée au dépôt et à la diffusion de documents scientifiques de niveau recherche, publiés ou non, émanant des établissements d'enseignement et de recherche français ou étrangers, des laboratoires publics ou privés.

Distributed Physical-layer Network Coding MAC Protocol

Mohammed AISSAOUI^{a,b}, Chiraz HOUAIDIA^a, Adrien VAN DEN BOSSCHE^b, Thierry VAL^b, Leïla AZOUZ SAIDANE^a

^aENSI, University of Manouba, Tunisia

^bIRIT, University of Toulouse - Jean Jaurès, France

Abstract

Physical-layer Network Coding (PNC) was first proposed for a Two-Way Relay Channel (TWRC) to improve the spectrum efficiency since it allows nodes to transmit simultaneously via a relay node. This technique requires multiple nodes to transmit their packets with accurate synchronization. Therefore, in many works of literature, centralized scheduling with perfect synchronization has been assumed to be employed on top of PNC.

Such assumptions are not applicable in general random access multi-hop wireless networks. Therefore, this paper proposes a distributed MAC protocol that supports PNC in static multi-hop wireless networks. The proposed MAC protocol is based on the Carrier Sense Multiple Access (CSMA) strategy, where RTS/CTS frames are used to detect PNC opportunities and to offer the appropriate scheduling of the involved transmissions that should occur simultaneously. This packet exchange process is coordinated by the relay node and was designed to guarantee compatibility with other conventional relaying schemes with specific concerns for the hidden node issues. Our solution was practically tested on a real testbed with different static wireless topologies and several physical settings.

With numerical results, we investigate the effectiveness of PNC in distributed wireless multi-hop networks. Compared to the conventional CSMA/CA and the PNC opportunistic (PNCOPP) MAC protocols, the proposed protocol's performances are advantageous in various scenarios, especially in large networks.

Keywords:

Multi-hop Wireless Networks, MAC protocol, Carrier-Sensing Multiple Access, Physical-Layer Network Coding, Two-Way Relay Channel, Software Defined Radio

1. Introduction

Ad-hoc networks have been considered a sub-class of multi-hop wireless networks consisting of self-organized, mobile, and eventually large-scale networks. Distinctive features such as low establishment cost and simple expansion have popularized those

networks as a promising technique for various Internet of Things (IoT) applications. However, since the capacity of these networks becomes increasingly constrained as the number of users grows, one of the main challenges is to meet the requirement of high throughput when the network is severely limited by interference.

Traditionally, Medium Access Control (MAC) protocols are designed to avoid interference scenarios and limit their appearance as much as possible. Recent advances in network coding have brought a new promising approach that exploits colliding signals to boost network performance.

In fact, the Physical-layer Network Coding (PNC) technique was first put forward in [1] to benefit from the interference in wireless networks. The basic idea is to allow nodes to transmit simultaneously and then extract the colliding packets using appropriate mathematical or logical operations rather than being ignored and deleted [2]. By this means, the data amount contained in each transmission will be increased, the bandwidth allocated to each node can be utilized more efficiently, and consequently, the overall network throughput will be improved.

The idea of the PNC technique could be illustrated using the Two-Way Relay Channel (TWRC) scenario or network, as shown in Figure 1. In this work, we adopt the TWRC for the PNC technique since it is the most representative, straightforward, and used scenario in the literature [1] [3] [4].

In this scenario, two nodes, A and B , exchange their data via the relay R . When considering a Half-duplex system, where each node has one antenna and can not transmit and receive simultaneously, in the traditional network (without NC), as shown in Figure 1 (a), the throughput is two packets by four-time slots.

Using the conventional network coding (NC) technique, as shown in Figure 1 (b), the relay encodes packets after receiving them in separate communication time slots. The encoding function is mainly an XOR operation for this TWRC topology [5]. Each edge node can then extract the in-

tended packet by XORing the coded packet with the initially sent packet. Therefore, the throughput is two packets by three-time slots using the NC technique, and a 33.33% of throughput improvement is achieved.

As shown in Figure 1 (c), the Physical-layer Network Coding (PNC) takes advantage of the naturally superposed electromagnetic waves and encodes packets through simultaneous transmissions in the Multiple Access Phase (MAP (Slot 1)). The encoding function of PNC can be either a multiplicative factor that amplifies the signal or an operator that maps the superposed signal to a series of bits representing the encoded packet [6]. Hence, PNC further reduces the number of required slots and guarantees an improvement of the throughput of 100% and 50% compared to the traditional and NC systems, respectively. In [4], network-analytical results were presented to prove the performance of the PNC technique in large networks.

In order to use and benefit from the PNC technique, the TWRC scenarios must be detected, and the PNC transmissions must be scheduled in a synchronized manner that allows such combinations. To do so and to coordinate channel access, a well-designed Medium Access Control (MAC) protocol is required.

In the literature, the centralized MAC protocols based on a Time/Frequency Division Multiple Access (TDMA/FDMA) are static and require centralized coordination, which is theoretically possible but is typically challenging to implement in distributed large-scale networks [6]. Therefore, random access-based MAC protocols were widely adopted, mainly the Carrier Sense Multiple Access (CSMA) based MAC protocols. However, the design of such MAC protocols, when supporting the PNC tech-

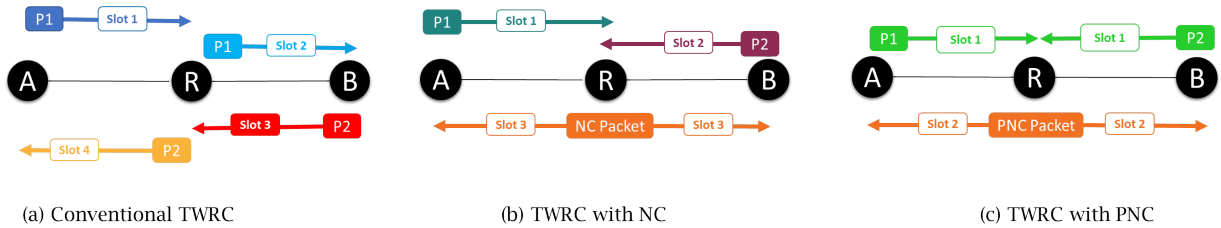

Figure 1: The three relaying techniques of the TWRC network.

nique, leads to high complexity since synchronization on the symbol level is needed [7] [8] [3] [9].

To the best of our knowledge, there is no complete solution in the literature that makes the use of the PNC technique in multi-hop wireless networks possible, taking into consideration all the possible challenges, mentioning: the full real-time knowledge about the topology and the neighbor node’s states required by nodes A , B , and R to detect the PNC opportunities, the synchronization of the edge nodes A and B in order to send their data to the relay node R simultaneously, and finally, the effect of the hidden stations (two nodes (stations) are hidden from each other if they are not in each other’s transmission and interference range.) in large-scale networks.

Hence, this paper’s focus is to design a distributed MAC protocol supporting the PNC and considering all the related issues previously introduced. Our solution, referred to as Distributed physical-layer Network Coding MAC Protocol (DNCP), is intended to be practically used in distributed large-scale static networks as tested and evaluated in a real testbed. DNCP is based on the well-known Distributed Coordination Function (DCF) of the IEEE 802.11 standard [10] where nodes randomly access the channel, and the MAC protocol detects the opportunity to perform PNC and offers the appropriate scheduling of the in-

volved transmissions that guarantees the best throughput.

In the following, Section 2 presents the related issues in the state of the art. Followed by the proposed PNC MAC protocol (DNCP) presented in detail in the third section. The fourth section presents the implementation and the performance results of the proposed DNCP in three different topologies, using the Software Defined Radios (SDRs) as hardware and the GNU Radio platform as software. Finally, the fifth section concludes our work and outlines possible future improvements.

2. Related works

The distributed control of communication networks remains a challenging area [11],[12], [6], [13], [4], [14], [15]. Recently, efforts on designing distributed MAC protocols that cover the PNC requirements have been proposed to make PNC applicable in practical systems.

The authors of [11] propose an opportunistic and distributed scheduling scheme based on the RTS/CTS (*Request to Send* and *Clear to Send*) mechanism between edge nodes via a relay node. However, this prior exchange is used only to coordinate the channel access, and the relay cannot distinguish between the ordinary and PNC data. It always applies the same amplify and forward steps and cannot detect the

PNC opportunities. Consequently, in the case of ordinary data, there might be additional delays for independent RTS/CTS between the relay node and the edge node, resulting in an 8-slot traffic pattern. Also, the channel access control of two source nodes uses only CTS messages, which are still unsubstantial until the two source nodes have already been synchronized with the relay node. On the other hand, the state information of the source node A must be known by the two-hop destination node B of the TWRC network.

In [14], authors propose that the node B of the TWRC scenario must send a specific Answer-To-Cooperate (ATC) message to the relay so that this latter can figure out that the subsequent transmission is a PNC transmission. However, hidden stations (the neighbors of one and two-hops of node A) can not figure out, whereas the transmission is an ordinary or PNC transmission. Therefore, they cannot wait until the end of the PNC transmission, which might cause collisions.

In [12], a PNC MAC protocol for wireless ad hoc local area networks has been proposed. Based on the Channel State Information (CSI) of the concurrent transmissions of different communication pairs, the proposed MAC protocol chooses the relay nodes dynamically, but it is a one-hop MAC protocol as they consider a fully connected network.

The distributed PNC MAC protocol proposed in [6] adopts a new policy by allowing the relay node to initiate the transmissions by sending an RTS message to the two edge nodes of the TWRC scenario, inviting them to coordinate their transmissions within a PNC opportunity. This process differs from the works in [11] and [12], where the source nodes initiate the transmissions.

To do so, the authors assume that the relay is already identified and has full real-time knowledge of the neighboring state and their MAC queues. Moreover, the authors assume that the nodes have real-time awareness of the network topology within at least a two-hop range, making the proposed protocol impractical for real implementation. Additionally, PNC communications will always have priority over ordinary transmissions. As a result, ordinary transmissions could never occur in some situations where PNC chances exist.

Authors in [16] propose a method to detect the PNC atoms (different scenarios of PNC on star network) in the star topology, based on the Point Coordination Function (PCF) mode of the IEEE 802.11 standard in order to skirt the problem of the real-time knowledge about the neighboring node's assumption. The two phases of the proposed MAC protocol are as follows: The coordination point (the relay) takes data from the edge nodes in the first phase and uses the PCF mode's fundamental polling mechanism to find PNC atoms. This relay affects each edge node to its respective data time slot in the second phase.

To accommodate the bidirectional traffic for one-hop random-access networks, authors of [13] propose an elective scheme for an optimal choice of a helper node to serve as a relay node in a TWRC scenario. Similar to [12], the selected helper node detects the PNC transmissions and plays the role of the relay node. The transmission process is as follows: first, the source node sends an RTS message to the destination node, and the destination node replays by sending a CTS message. After receiving the CTS message, the source node waits to receive a forwarder-to-send (FTS) frame from the helper node that indicates whether or not

there is a PNC opportunity. When a PNC opportunity arises, the source and destination nodes simultaneously send their data to the helper node, which forwards the received PNC data to the source and destination nodes. Besides the synchronization and hidden stations issues, this work suffers from collisions during the optimal helper node (relay) selection process.

An improved version of the work proposed in [13] is presented in [15], where many relaying nodes are chosen instead of just one relay node to enhance the system's performance and deal with the collision problem during the optimal helper node selection phase.

To summarize the state of the art, table 1 outlines the literature's limitations. We detail these primary shortcomings of the previous works in the following points:

- **The synchronization of the edge nodes to the relay node:** During the Multiple Access Phase (MAP) of the PNC transmission, the two edge nodes A and B of the TWRC scenario must be synchronized. This step is crucial for successful PNC transmission, ensuring that edge nodes A and B transmit simultaneously. Therefore, the relay node can effectively receive and map the data from both nodes A and B into PNC data. The synchronization process of the two edge nodes A and B to the relay node R requires multiple exchanges of messages (at least two) [17, 18, 4, 19, 9, 20, 21].
- **The full real-time knowledge about the topology and the neighboring state:** In order to organize and schedule the node's transmissions, they must know the type of the outgoing

transmission, whether it is an ordinary or PNC transmission. Therefore, the network's nodes must have real-time knowledge about each other's state (information about the data to be sent), at least, the two-hop range. Thus, the works in the literature are divided into three categories: works that deal with real-time knowledge with the messages exchange [4] [14] [16], works that use a specific typology [12] [13] [15], and works that put assumptions [11] [6].

- **The necessity of the transmission range to reach all the network's nodes in one-hop networks (fully connected networks):** Some works like [12, 13, 15] have set this requirement to provide real-time knowledge about the topology and the neighboring state.
- **The effect of the hidden stations:** The previous works did not consider the effect of the hidden stations of all three nodes of the TWRC network. At most, they treat the hidden stations of the edge node B and the relay R only [11, 14, 6], whereas the hidden stations on the side of node A are not resolved. Therefore, those MAC protocols can not be deployed in large-scale networks.

Hereafter, we present our distributed PNC MAC protocol DNCP, which supports the PNC technique and addresses the abovementioned literature's limitations, outlined in table 1. To the best of our knowledge, we are the first to practically implement a distributed solution on a real testbed using SDRs for TWRC extended topologies (more than three nodes of the TWRC network).

Table 1: The literature’s limitations

Ref.	Nodes synchronization	Topology awareness	Neighbor-ing state awareness	Custom topology	Hidden station issue
[11]	X	X	X		X
[17]	X				X
[12]		X		X	
[18]	X				X
[6]		X			X
[13]		X		X	
[4]	X		X		X
[16]			X		
[19]	X				X
[9]	X				X
[20]	X				X
[14]			X		X
[21]	X				X
[15]		X		X	

3. Distributed Physical-layer Network Coding MAC Protocol

Applying PNC approaches in large random wireless multi-hop networks may result in some design complexity, making performance analysis challenging. Therefore, most existing works use the three TWRC nodes scenario, make many restrictive assumptions, and evaluate the proposed solutions in the most straightforward way. To our knowledge, there is no existing complete work ready to be deployed in large and dense random wireless multi-hop networks. This paper presents the first full PNC MAC protocol, called Distributed Physical-layer Network Coding MAC Protocol (DNCP), based on the Distributed Coordination Function (DCF) of the IEEE 802.11 standard [10].

We address the major design considera-

tions outlined hereafter:

- **Detecting PNC opportunities:** Before transmitting a packet, each edge node should check whether its data can be coded with another data flow so that there is coordination between the transmitting nodes and that their transmissions can occur simultaneously.
- **Coordinating simultaneous transmissions:** When performing PNC, the source nodes carrying the packets to be encoded must be aware of the appropriate transmission time slot.
- **Considering the effect of hidden stations in large-scale networks:** Because performing PNC may not always be possible and advantageous,

the proposed protocol should guarantee compatibility with other conventional relaying schemes so that ordinary data transmissions (not part of a PNC opportunity) still occur correctly. When performing PNC, the neighboring nodes of the involved nodes in the PNC opportunity should also be informed in order to avoid destructive collisions.

- **Real-world evaluation:** In order to have a practical solution, we address effective assumptions and try to abide by the hardware requirements.

3.1. System Modelling

In this section, we discuss the basic principles of the proposed DNCP protocol. To do so, we model our network topology as presented in Figure 2, where two nodes, A and B , will exchange data via a relay node R . The remaining three nodes, C , D , and E , are hidden stations.

We assume that all nodes are static and the edge nodes are far enough apart to require a multi-hop relaying scheme to communicate. We also suppose that nodes are located at the same distance apart, and all nodes have the same transmission/communication range and the same interference/sensing range as depicted for the relay node in Figure 2.

All transmissions are conducted through single-channel mode. The half-duplex restriction mandates that a node cannot send and receive packets simultaneously. Note also that links are bidirectional, which allows PNC opportunities. When performing PNC, the transmitting nodes simultaneously transmit their original source packets, and we restrict the number of packets encoded to two so that each node in-

involved in the PNC process XOR-encodes two packets belonging to different flows into a single coded packet. In this paper, since implementing a routing protocol is out of the scope of this work, we also assume a static routing, allowing nodes to be aware of routes toward all the possible destinations and the corresponding next-hop nodes in a complete system, where all layers are implemented (Physical, MAC, Network (routing), etc.). These informations could be extracted or received from the network layer (routing protocol) in a cross-layer system.

Considering this network modeling, we can distinguish two possible types of transmissions: one-hop or multi-hop transmissions, according to the number of hops to reach the final destination node. For the one-hop transmissions, the next node is the final destination node. Therefore, there is only one scenario, which is a one-hop ordinary transmission. Whereas, there are two possible scenarios for the multi-hop transmissions: a PNC or an ordinary multi-hop transmission. Indeed, the PNC transmission takes place if there is a PNC opportunity. Otherwise, the multi-hop ordinary transmission occurs (if there is no PNC opportunity). The details of each transmission's scenario will be presented in what follows.

For the one-hop transmissions, the same RTS/CTS process of the DCF (IEEE 802.11 standard) will be adopted.

As the present work aims to perform PNC, we are focusing only on multi-hop transmissions where at least one relay node is required to have a successful data exchange between any pair of nodes. Hence, the PNC technique will be applied if there is a PNC opportunity (i.e., two source nodes sending two bidirectional data flows via a relay node); otherwise, an ordinary trans-

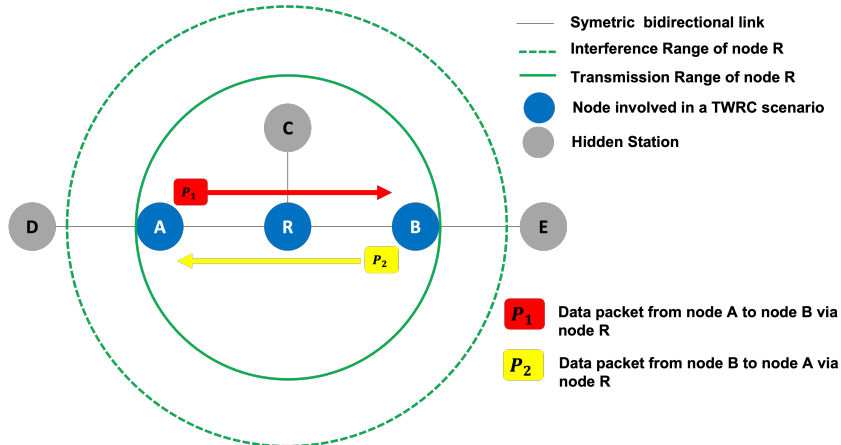

Figure 2: The considered network topology.

mission without the PNC technique takes place. Hereafter, we distinguish the two cases.

3.2. PNC Packet Exchange Process

To better understand PNC transmission, look at the timing diagram shown by Figure 3 as an illustrative example. In this scenario, node A wants to send data packet P_1 to the final destination node B via the node R . Simultaneously, node B has data packet P_2 for node A according to its queue status. As a result, a TWRC scenario exists between the nodes A , B , and R , which will act as a relay node. The DNCP was proposed in order to benefit from the PNC opportunities. To address the shortcomings of state of the art, as previously noted, DNCP introduces newly adopted policies based on the Distributed Coordination Function (DCF) of the IEEE 802.11 (RTS/CTS) standard [10]. The node A first senses the channel for a $DIFS$ ($DIFS$: DCF Interframe Space, $SIFS$: $Short$ InterFrame Space) then sends a Request To Send RTS_{AB} frame to node R , which forwards a PNC Request $PNCR_{AB}$ to node B (in large-scale networks, the final destination is replaced by the two hop destination node of the source node). Since the

node B has data to A , it answers by a PNC Confirm ($PNCC_{AB}$) frame to the node R to announce that it is ready to perform a PNC packet exchange with node A .

The node R , then, sends back a Clear To Send frame (CTS_{AB}) to the edge nodes A and B of the detected TWRC scenario. By receiving this CTS_{AB} frame, node A broadcasts a final confirm frame $PNC_{confirm}$ to inform the hidden station D of the relay node R that a PNC transmission is coming. In parallel, the two nodes A and B start a *timeout*; this timeout is used to synchronize simultaneous transmissions between the two nodes A and B . It will allow node B to wait until node A sends its control frame $PNC_{confirm}$. Node A also waits for the same *timeout* as node B after receiving the CTS_{AB} frame to synchronize their simultaneous data transmissions.

Then, the two nodes already coordinated, transmit their respective data packets P_1 and P_2 simultaneously to the relay node R , which maps the two received packets into a PNC data packet $PNCDATA_{P_1P_2}$. Each edge node receiving the coded packet correctly decodes it and replies with an acknowledgment frame ACK to the relay

node, indicating the end of this PNC transmission.

If these ACKs are sent at the same time, the relay will receive superposed (overlapped) ACKs. In this work, we adopt the relaying technique Decode and Forward (DAF) combined with the OFDM technology as described in section 4 to help the relay node to extract and decode the superposed ACK frames received from the two edge nodes A and B . Many other techniques proposed in [22, 23, 24, 25, 26, 27, 28] could be used for that purpose for which the main differences are about channel state information (CSI), carrier offset, modulation, and synchronization.

Therefore, the reception of the ACKs indicates that both A and B , respectively, are confirming the reception of the data packet $PNC\ DATA_{P_1P_2}$. Otherwise, the relay node will receive only one ACK packet or not receive any ACK frame at all, which will be addressed as failed transmission, and the relay node will perform the exception handling accordingly as in subsection 3.5.

3.3. Multi-hop Ordinary Transmission

In this case, as shown in Figure 4, when the relay forwards to B the request of a PNC exchange with A and since node B does not have any data to transmit to A at the same time, it sends back a Negative PNC frame (NEG_{PNC}) to indicate that it is ready to receive the data packet from A but cannot collaborate in a TWRC scenario. Therefore, the relay node sends a simple CTS_A control frame to inform the source and the destination nodes A and B , respectively, that a multi-hop ordinary transmission is coming. After which, a unicast relaying scheme is employed to deliver A 's packet to B with respect to the conventional IEEE

802.11 MAC protocol and the traditional NAV setting for hidden stations.

3.4. NAV Setting

This subsection presents the Network Allocation Vector (NAV) lengths (time length) for the different aforementioned scenarios. This technique is called Virtual Carrier Sensing (VCS) [29], which is used by the hidden stations (nodes D , E , and C) other than the TWRC nodes (A , B , and R) in order to sleep (do not transmit) during the PNC or Ordinary transmissions to prevent collisions.

In our examples shown by Figure 3 and Figure 4, for PNC and multi-hop ordinary transmissions, respectively, there are three hidden stations, nodes D , E , and C . The NAV of the two nodes D and C have two phases. The first phase is used before the reception of the message, which indicates whether there is a PNC transmission or not. The second stage is used after the encoded data message, which represents an update of the NAV based on the type of the upcoming transmission. For the node E , its NAV only has one stage, which begins after receiving the message $PNC\ CC_{AB}$ or NEG_{PNC} for PNC or Multi-hop ordinary transmission, respectively.

The NAV of the first node D (neighbor of node A) will be updated after receiving the $PNC\ CONFIRM$ or $ORD\ CONFIRM$ (*Ordinary confirm*) message, which indicates whether the transmission is a PNC or ordinary transmission, whereas the second node C updates the NAV after the reception of the CTS_{AB} or CTS_A message. The node E updates its NAV after receiving the $PNC\ CC_{AB}$ or NEG_{PNC} message, which already indicates the type of the upcoming transmission.

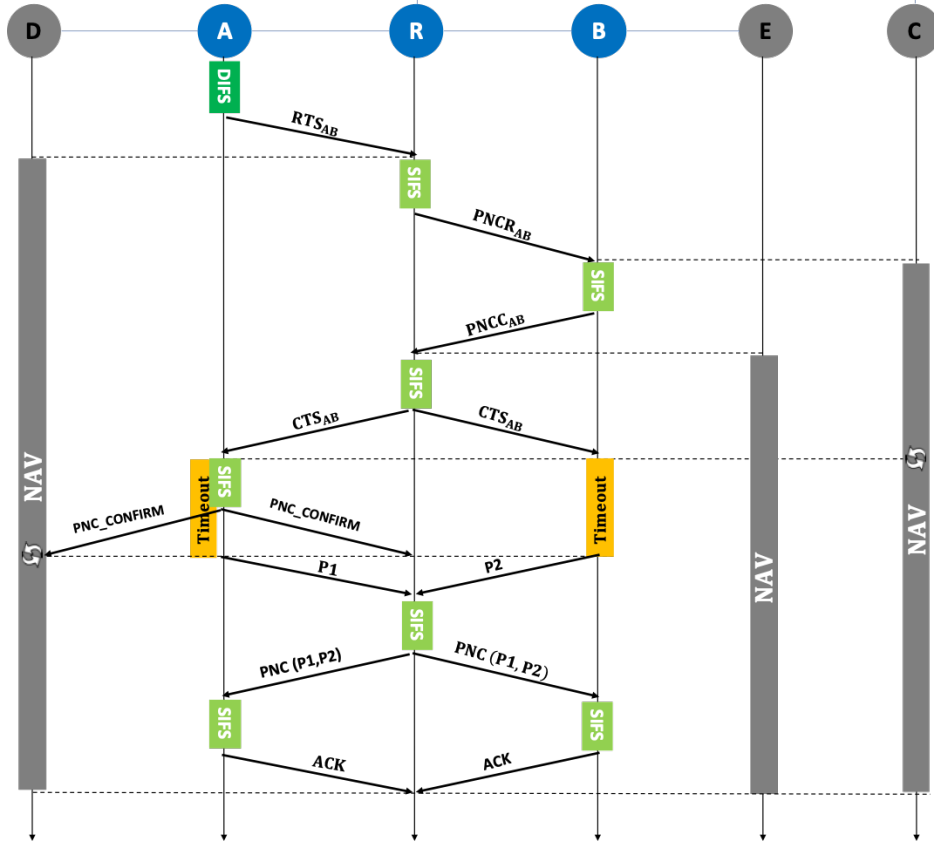

Figure 3: Example of a multi-hop PNC transmission.

The NAV's time lengths of nodes D , C , and E are computed by Equations 1, 2, and 3 for the multi-hop PNC transmission, and by Equations 4, 5, and 6 for the multi-hop ordinary transmission, respectively:

$$\begin{aligned}
 T_{NAV_D_PNC} &= 6T_{SIFS} + T_{PNC_{RAB}} + T_{PNC_{CAB}} \\
 &\quad + T_{CTS_{AB}} + T_{PNC_{confirm}} + T_{P_1} \\
 &\quad + T_{PNC_{DATA_{P_1P_2}}} + T_{ACK}
 \end{aligned} \tag{1}$$

$$\begin{aligned}
 T_{NAV_C_PNC} &= 5T_{SIFS} + T_{PNC_{CAB}} + T_{CTS_{AB}} \\
 &\quad + T_{PNC_{confirm}} + T_{P_1} + T_{PNC_{DATA_{P_1P_2}}} + T_{ACK}
 \end{aligned} \tag{2}$$

$$\begin{aligned}
 T_{NAV_E_PNC} &= 4T_{SIFS} + T_{CTS_{AB}} + T_{PNC_{confirm}} \\
 &\quad + T_{P_2} + T_{PNC_{DATA_{P_1P_2}}} + T_{ACK}
 \end{aligned} \tag{3}$$

$$\begin{aligned}
 T_{NAV_D_ORD} &= 7T_{SIFS} + T_{PNC_{RAB}} \\
 &\quad + T_{NEG_PNC_{AB}} + T_{CTS_A} + T_{ORD_{confirm}} \\
 &\quad + 2T_{P_1} + 2T_{ACK}
 \end{aligned} \tag{4}$$

$$\begin{aligned}
 T_{NAV_C_ORD} &= 6T_{SIFS} + T_{NEG_PNC_{AB}} + T_{CTS_A} \\
 &\quad + T_{ORD_{confirm}} + 2T_{P_1} + 2T_{ACK}
 \end{aligned} \tag{5}$$

$$\begin{aligned}
 T_{NAV_E_ORD} &= 5T_{SIFS} + T_{CTS_A} + T_{ORD_{confirm}} \\
 &\quad + 2T_{P_1} + 2T_{ACK}
 \end{aligned} \tag{6}$$

3.5. Handling Exceptions

We presented in Section 3.2 and 3.3 the basic process of PNC and Multi-hop Ordinary packet transmission, respectively.

This section presents the exceptional cases

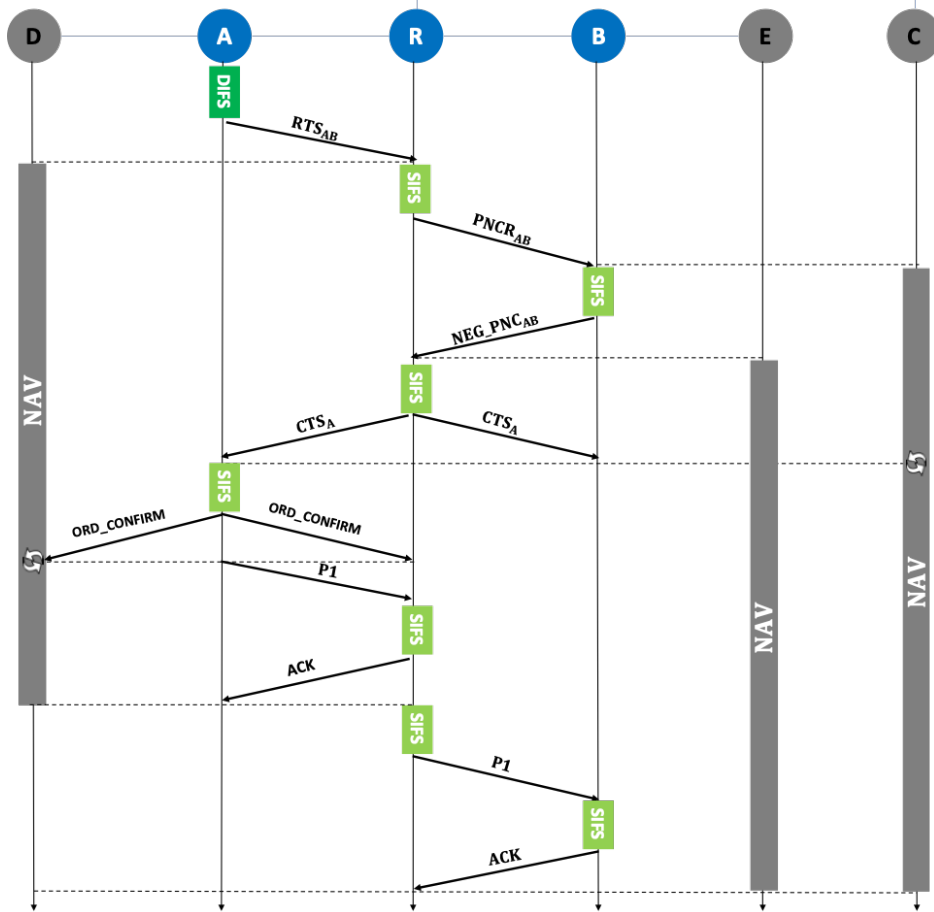

Figure 4: Example of a multi-hop ordinary transmission.

caused by frame loss (or corruption) and introduces how DNCP handles these cases.

We discuss the most critical cases, depending on the lost frame, as follows:

- **PNC_{AB} or NEG_PNC_{AB} :**
This means that the node B did not receive the $PNC_{R_{AB}}$ message of the relay node R , or it does not exist. Therefore, the node R sends a CTS message (the same as the RTS/CTS process of the DCF) to authorize a one-hop ordinary transmission with node A .
- **CTS or CTS_{AB} or CTS_A :** In this case, there are two situations. The first

one is that the node A wants to send a one-hop packet, and it did not receive the CTS message, the same as the RTS/CTS process of the DCF. So, it cancels the transmission and tries again in another round. In the second situation, the node A wants to send a multi-hop packet, and it did not receive a CTS_{AB} or CTS_A message. In this situation, the nodes A , B , and C all are concerned. The nodes A and B cancel the transmission and try again in another round. However, the node C will not update its NAV and considers that the transmission has failed.

- ***PNC_{confirm} or ORD_{confirm}*** : Here, the node *D* will not update its *NAV*, which means the transmission failed.
- ***ORD_DATA*** : Here, there are three situations: the first is during one-hop packet transmission. In this case, the node *R* or any receiving node cancels the transmission and considers that the transmission has failed. The second case is during multi-hop ordinary packet transmission. Here, either node *R* or *B*, consider that the transmission has failed. Finally, the third situation is a PNC packet transmission. If the relay node receives only one ordinary data packet from one edge node, it forwards this data to the other destination edge node and considers it a multi-hop ordinary transmission. However, if it did not receive any ordinary data, it cancels the transmission and considers that it has failed.
- ***PNC_DATA***: If one of the edge nodes *A* and *B*, or the two, did not receive the *PNC_DATA*, they consider that the transmission has failed and try again in another round.
- ***PNC_ACK*** : If the relay node *R* receives only one *PNC_ACK* for one edge node, it sends the received *PNC_DATA* in another round to the other edge node. Whereas, if it did not receive any *PNC_ACK*, it broadcast the received *PNC_DATA* in another round to both edge nodes *A* and *B*.
- ***ACK*** : If a node did not receive an ordinary *ACK*, it considers that the transmission has failed and tries to

send this ordinary DATA again in another round.

- **Duplicate packets** : If a node receives a duplicate PNC or ordinary data packet, it sends a *PNC_ACK* or *ACK*, respectively, and deletes the received data packet.

The flowcharts shown in Figure 5 and Figure 6 summarize all the possible cases (sent, received, and lost frames) of the DNCP for the source node and any receiving node (relay, destination, and hidden station), respectively.

To sum up, the DNCP protocol stands for the following outlined policies that make it reliable, practicable, and suitable for multi-hop large-scale networks:

- **Reliable coordination:** Involved nodes in the TWRC scenario could carry their clock information in the control frames (RTS, CTS, ...) to coordinate the channel access between them and guarantee a simultaneous data transmission when performing PNC. The initial synchronization of the clocks of the nodes can be inspired from [30], [17], [19], [18], [4], [20], [9], and [21].
- **No full real-time knowledge:** Using the DNCP, all information required to check and maintain a PNC opportunity is either local or extracted from the control frames. Therefore, there is no need for full real-time knowledge about the topology or the queuing status of neighboring nodes.
- **No additional delays due to empty time slots:** DNCP is a distributed MAC protocol, which implies that it

does not suffer from the delay linked to the static TDMA-like MAC protocols, where there can be empty time slots and not used [3] [4].

- **No necessity of dedicated network topologies:** DNCP does not require specified or dedicated topologies to be deployed (for example, the transmission range to reach all the network's nodes as in [12, 13, 15]). Therefore, it can be deployed on any multi-hop wireless network.
- **No hidden station's problem:** Thanks to an efficient NAV configuration mechanism coupled with a systematic exchange of control messages, the hidden stations can properly delay their access to the channel and thus avoid what was initially called "*destructive interference*".

3.6. Framing

In this subsection, we discuss the framing of the proposed DNCP protocol. The frames are designed to contain the necessary information, as discussed in previous sections. Figures 7 (a) and 7 (b) summarize the formats of control and data frames, which are modified according to the IEEE 802.11 standard.

The *MAC header* is illustrated in Figure 7(c), which includes the type of the message (Frame control), the duration, the destination MAC address, the source MAC address, the final destination MAC address, the Access point's Basic Service Set (BSS) MAC address, the sequence number (Sequence number 1), and the sequence number (Sequence number 2) of the second data frame if the data frame is a PNC data.

4. Implementation and Results

In this section, we present a real implementation of the DNCP using a Software Defined Radio (SDR) based testbed. More specifically, we have used GNU Radio [31] as software and Universal Software Radio Peripheral (USRP) [32] as hardware. The version of the GNU Radio used is 3.7.14, which is well-documented and supported. While for the hardware, we used the FIT/CorteXlab testbed [33], particularly the *USRPN2932*.

4.1. Experimentation Setup

To begin with, we used the TWRC network shown in Figure 8 to infer how the DNCP would behave with the TWRC scenarios.

Next, in order to analyze the impact of the hidden station's problem on our solution, we adopted the topology shown in Figure 9, which we refer to as the *FullTopology*.

We consider, as illustrated in Figure 9, that nodes *A* and *B* are, on the one hand, involved in a TWRC scenario via the relay node *R* and, on the other hand, are exchanging data flows with their respective neighbor nodes *D* and *E*. This data configuration was motivated by the need to have ordinary transmissions as well as PNC ones.

Finally, the Line topology, depicted by Figure 10, is used to deduce the effects of successive relays in a large-scale multi-hop network. In this topology, the two edge nodes, *A* and *F*, are exchanging data simultaneously via the intermediate nodes *B*, *C*, *D*, and *E*. Thus, each intermediate node in this scenario could be a relay node.

We built a three-layered prototype using the GNU Radio Platform where the application layer generates data packets, the MAC

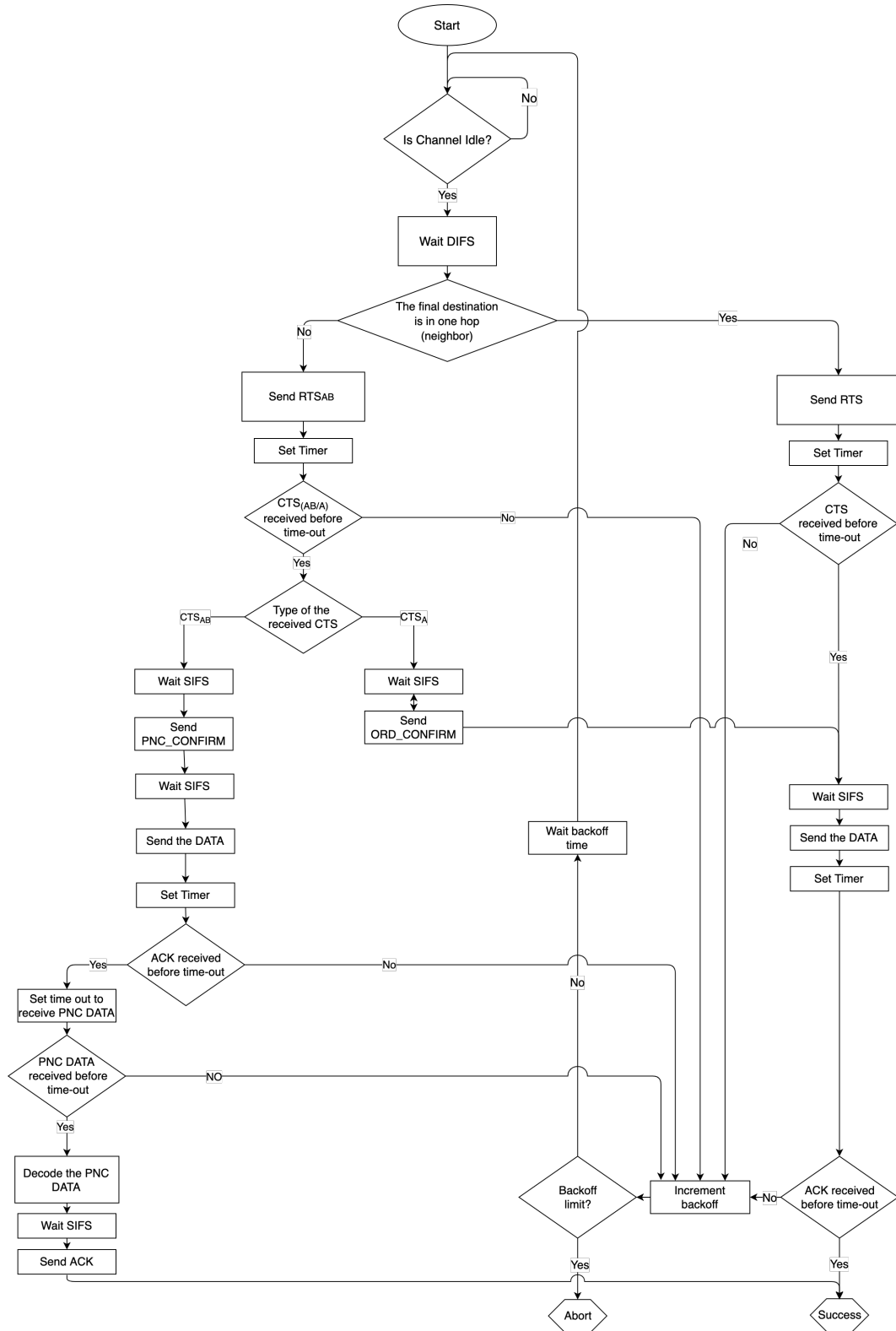

Figure 5: Flowchart of the source node.

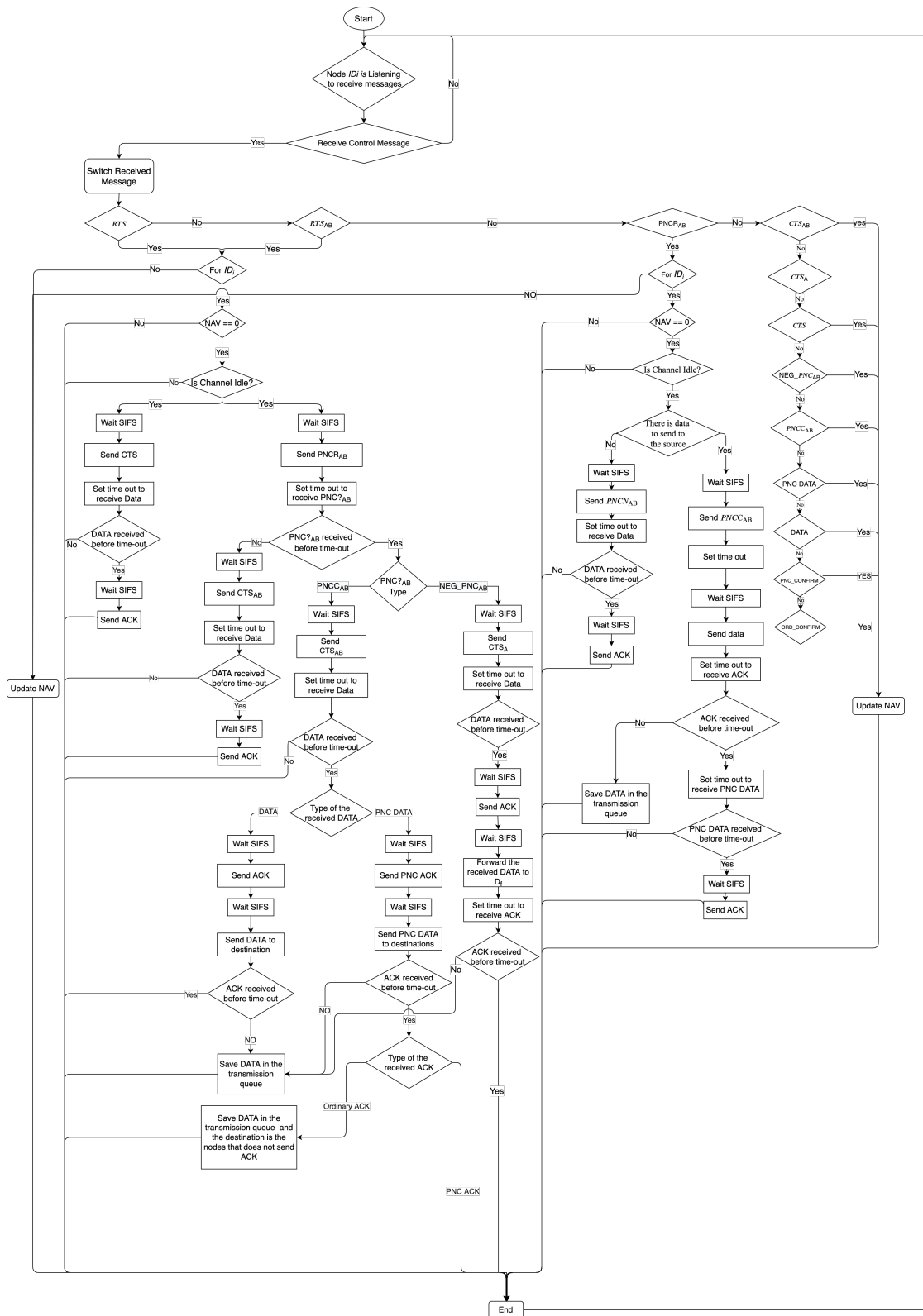

Figure 6: Flowchart of the relay, destination, and hidden station.

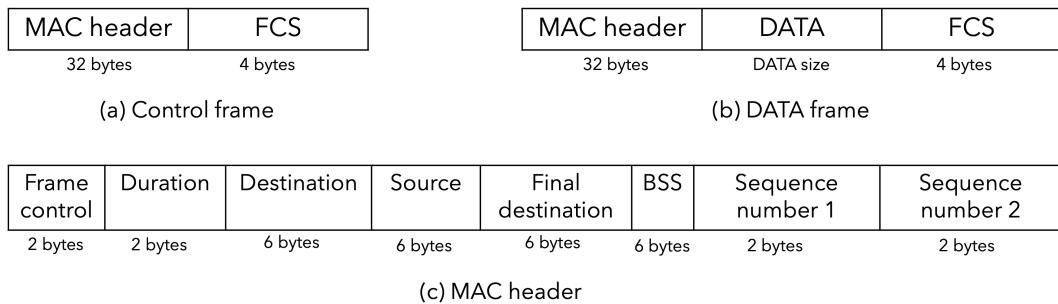

Figure 7: DNCP's MAC Frame.

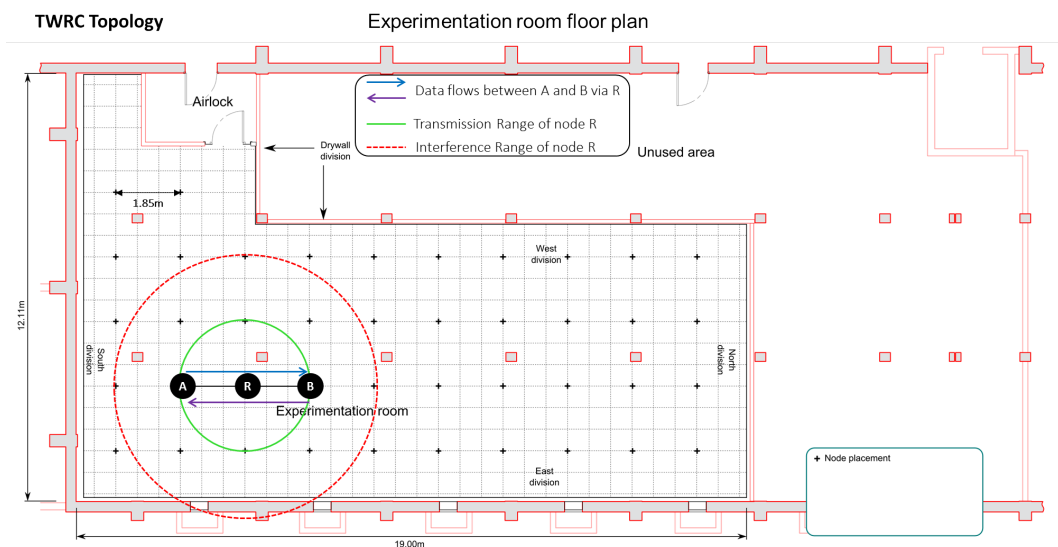

Figure 8: The TWRC Topology.

layer implements our protocol DNCP, and the Physical layer performs on WIFI proposed in [34] [35].

For the application layer, the block *Message Strobe*¹ of the *Debug Tools* GNU radio module is used to create data packets from text. However, we built a new GNU Radio module for the MAC layer for our proposed MAC protocol called DNCP. We based our implementation on the well-known CSMA/CA MAC protocol proposed in [36].

¹https://wiki.gnuradio.org/index.php/Message_Strobe

Node synchronization was the first challenge we had to handle in our implementation. All the existing distributed clock synchronization protocols that provide the level of synchronization required by the PNC technique are either implemented on an Application Specific Integrated Circuit (ASIC) [37] or a Field Programmable Gate Array (FPGA) [38] [9]. These solutions are not compatible with the General Purpose Processors (GPP) based SDRs, where most signal processing operations are performed in the personal computer on top of the SDR, and the synchronization does not take place according to deterministic

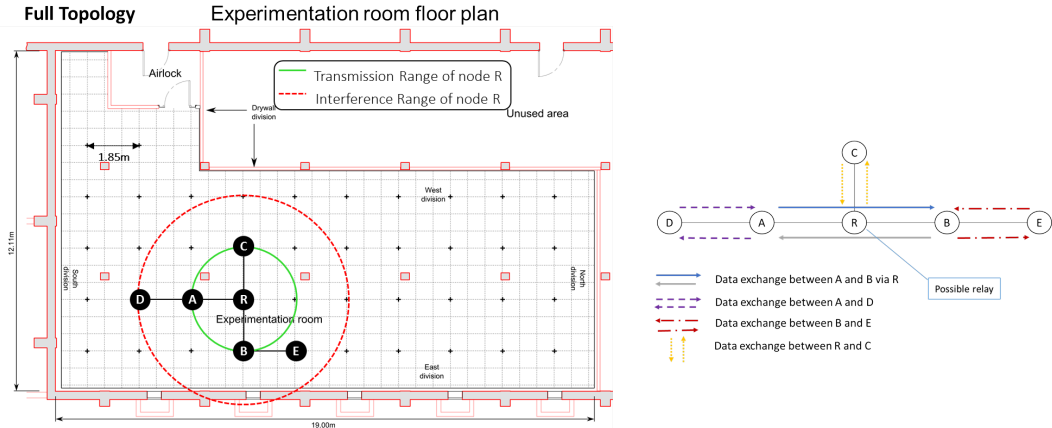

Figure 9: The full topology.

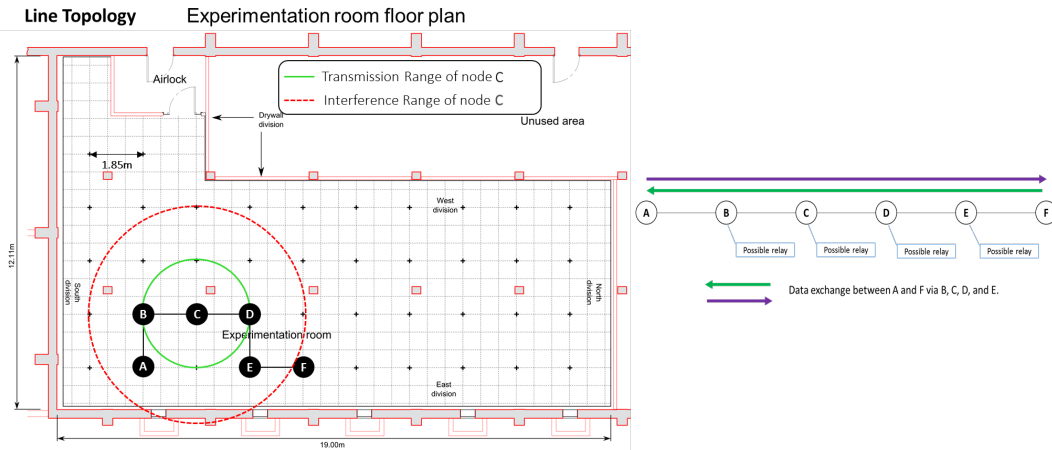

Figure 10: The Line topology.

time sequences as in ASIC and FPGA platforms [9]. To the best of our knowledge, all the existing implementations that ensure the level of synchronization required by the PNC technique are centralized and based, either on Global Positioning System disciplined Oscillators (GPSO/GPS) [24] [25], or based on the SDR's Gigabit Ethernet [9] [39], for example using the Ettus Octoclock [40]. When dealing with distributed implementations, we used OFDM technology [41] to avoid such a level of synchronization [42, 22, 43, 20, 44, 45] where all the schedules are done using the control bea-

con frames as in the 802.11 standard [10] [22] and no more additional overhead is incurred.

When focusing on the physical layer, the key challenges were timing and frequency asynchrony in wireless transmissions due to the mismatch between the transmitter and receiver hardware clocks and channel effect [43][46]. Carrier Frequency Offset (CFO) between the transmitter and the receiver would cause inter-subcarrier interference if left uncorrected. Then, to tackle these challenges, the timing offset and the frequency offset have been estimated with

OFDM Synchronizer block performing the Schmidl-Cox algorithm as described in detail in our previous work [47]. The main idea of this solution is to take advantage of the OFDM frame structure to find the starting point of the frame as well as estimate and suppress the frequency offset of received symbols.

At the MAC layer, the result of our new module is a *GNU Radio Companion (GRC)* block called *DNCP*² as shown in Figure 11. This block comprises multiple ports and parameters as summarized in Table 2 and Table 4, respectively.

It is worth noting that the parameter *ALPHA* is used to multiply the time slot, the SIFS, and the DIFS in order to increase the waiting time of the MAC layer since all the processes will be done by the GNU Radio software, which is not fast enough compared to integrated FPGA's software [48]. The parameter *Threshold* refers to the received power limit for which the channel is considered busy.

The MAC and PHY layer's parameters are shown, respectively, in Table 3 and Table 4, which are the default parameters recommended in literature [36].

In a prior experiment, we first check the channel state when idle and during transmission. This helps us to estimate the noise made by neighboring nodes properly and to correctly configure the signal power for which the channel is considered busy in our experiments. Figure 12 shows the channel's state during transmission and idle mode. During the idle mode (green dashed line), the received signal power is always around $-100dBm$ since the CorteXlab environment is isolated (indoor environment),

whereas, during the transmission mode (red continued line), there are four levels of the received signal power. The first level is around $-100dBm$, which indicates that no transmission is taking place at this time (or idle). The other levels (around $-80dBm$, $-60dBm$, and $-40dBm$, for weak, medium, and high signal power, respectively) represent that a transmission is taking place. In our experiments, we consider the medium signal power ($-60dBm$) as a threshold to indicate that the channel is busy by data transmissions, and any other weak signal (lower or equal to $-80dBm$) is considered noise.

The DNCP's performances are evaluated for the three aforementioned *TWRC*, *Line*, and *Full* topologies and are compared with the conventional CSMA/CA MAC protocol and the opportunistic protocol (PNCOPP) proposed in [11] using four metrics: the throughput, the delay, the packet loss rate, and the packet drop rate since these metrics are the most impacted by the PNC technique. Each experiment lasted 50 minutes and was repeated five times. The considered confidence interval for the results is 95%.

4.2. Results Analysis

The average throughput of all the nodes is expressed in Kbits/s and measures the total number of bits of received packets during the experimentation period.

In order to estimate the overall delay induced by our MAC protocol, we estimate the average local delay of each data frame for each experiment. This delay identifies the average time between entering the local MAC layer buffer and transmitting the corresponding signal by the physical layer during a successful data packet transmission between any pair of nodes. We assume that

²<https://cloud.irit.fr/s/dxUIXdqeLHAzCFM>

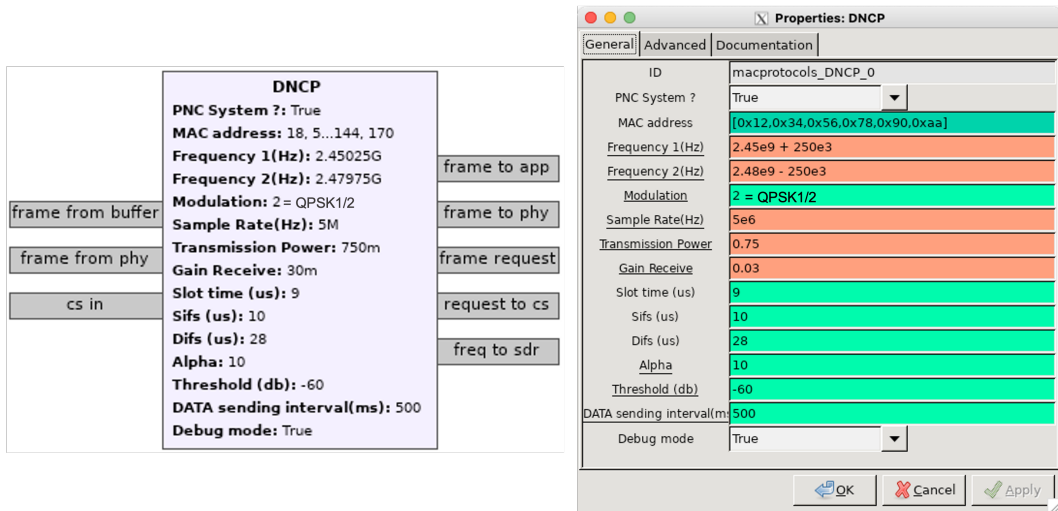

Figure 11: The DNCP GRC block.

Table 2: Description of Ports used in the DNCP GRC Block

Ports	Description
Frame to app	Sends a data frame from the MAC layer to the application layer
Frame to phy	Sends a data frame from the MAC layer to the physical layer
Frame request	Requests a frame from the packet queue
Request to CS	Requests the Carrier Sense (CS) of the transmission channel
Freq to SDR	Changes the frequency of the transmitting SDR
Frame from buffer	Receives a data frame from the application layer to the MAC layer
Frame from phy	Receives a data frame from the physical layer to the MAC layer
CS in	Receives the value returned by the Carrier Sensing operation

there are no buffering delays in the physical layer so that the received data frame from the MAC layer is immediately transmitted. Also, we counted only successful transmissions for which the sending node received a positive acknowledgment. This period includes all potential delays for queuing, channel access, control frames transmission, inter-frame spaces, Etc.

The third metric is the packet's loss rate, which is computed based on the ratio of the number of lost packets from all the sent packets. This loss may be caused by error,

data corruption, destructive interference, or breakable links, and we do not consider loss caused by saturated buffers.

Finally, the fourth metric is the packet's drop rate, which represents the ratio of dropped packets from all sent ones. We consider that a packet is dropped only if the MAC layer buffer is full or the maximum number of sending retries is reached. This metric estimates the impact of PNC transmissions on ordinary transmissions.

The performance results of the proposed DNCP, the PNCOPP, and the well-known

Table 3: MAC Layer Configuration

Parameters	Values
Size of the application layer buffer	250 data frames
Size of the local MAC layer buffer	3 data frames
Average delay of the GNU Radio block	1000 μ s (1ms)
Maximum retries to send a data packet	10
Physical layer delay to receive a data frame	1 (μ s) for a maximum distance of 300m between two nodes
CWmin	16
CWmax	1024

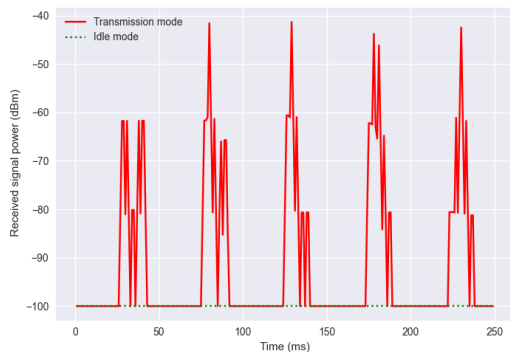

Figure 12: Channel State Check.

CSMA/CA MAC protocols on the mentioned topologies are presented in the following sections.

4.3. Results of the TWRC topology

This section presents the results of the DNCP, PNCOPP, and CSMA/CA MAC protocols on the TWRC network. For this simple topology, we first study the impact of the modulation technique on the network's performance. This choice was motivated by the analysis made in a previous work [49], which revealed an important correlation between the modulation technique used in the physical layer and the performances drawn from the PNC. Indeed, it was proven that

OFDM-based PNC is vulnerable to carrier frequency offset (CFO), which can be induced by node mobility and/or local oscillator (LO) mismatch between transmitters and receivers. This CFO cannot be estimated and eliminated in PNC at the relay node, which generally faces two different CFO values from the edge nodes A and B . CFO in PNC results in not only the inter-carrier interference (ICI) between the subcarriers of nodes A and B , but also a relative phase offset between the received constellations of nodes A and B , and both will cause performance loss in PNC, especially for high-order modulations including QPSK [50] [51]. The rationale behind this first set of experiments is to evaluate our MAC protocol under different modulations in order to figure out the more appropriate PHY configuration to obtain the best performances.

The results of five experiments of each configuration are considered. Each composition experiment has been running for two minutes: for example, the sample rate 10MHz with the modulation BPSK1/2, and so on.

To take a broader view, Figures 13(a), 13(b), 13(c), 13(d) show the results average

Table 4: PHY Layer Configuration

Parameters	Values
Central frequency f	$f = 2.45GHz$
Shift frequency β	$\beta = 250KHz$
Frequency 1	$f + \beta$
Frequency 2	$f - \beta$
Sample Rate	10MHzs
Modulation	BPSK1/2 (1/2 is the code rate), BPSK3/4, QPSK1/2, QPSK3/4, 16QAM1/2, 16QAM3/4, 64QAM1/2, and 64QAM3/4
Transmission Power	0.75 (Normalized gain $\in [0.0, 1.0]$)
Received Gain	0.03 (Normalized gain $\in [0.0, 1.0]$)
Threshold CS	-60
Alpha	10
DATA packet's length	500 bytes
Data packet's production time interval	500 ms

of all the modulations used for the throughput, delay, packet loss rate and packet drop rate, respectively.

For the throughput, the DNCP outperforms the CSMA/CA MAC protocol regardless of the modulation used, except for the 64QAM modulation.

For all the performance metrics, we note that the modulation *QPSK* gives the best performance. Results also show that the higher the *M*-PSK modulation order, the higher the performance is, whereas, for the *M*-QAM modulation, the higher the modulation order is, the lower the performance is. The reason is that the *M*-QAM modulation is highly affected by the received Signal Noise Ratio (SNR) or Signal to Interference plus Noise Ratio (SINR), which requires higher levels of transmitter power and Receiver gain, especially with the PNC transmissions, where two signal received at the same time, in contrast with the *MPSK* modulation, which is highly resistant to the

SNR or SINR [52, 53, 24, 54, 55, 56].

We easily determine that for all the performance metrics, DNCP outperforms the conventional CSMA/CA protocol except for *M*-QAM modulation.

This is caused by the Decode-and-forward (DAF) method used for PNC transmissions. Indeed, when using DAF with binary phase-shift keying (BPSK) or quadrature phase-shift keying (QPSK) modulations, the superposed signal can be mapped to the coded signal with the XOR operation. However, the XOR mapping method may not be suitable for higher-level modulations [52].

Thus, in some cases, using this modulation, the encoding/decoding process will lead to erroneous packets, therefore retransmitted or ignored, which explains the drop in performance of our protocol in these scenarios.

Figures 13(a), 13(b), 13(c), and 13(d) also show the good performance of the PN-COPP over the DNCP and CSMA/CA for

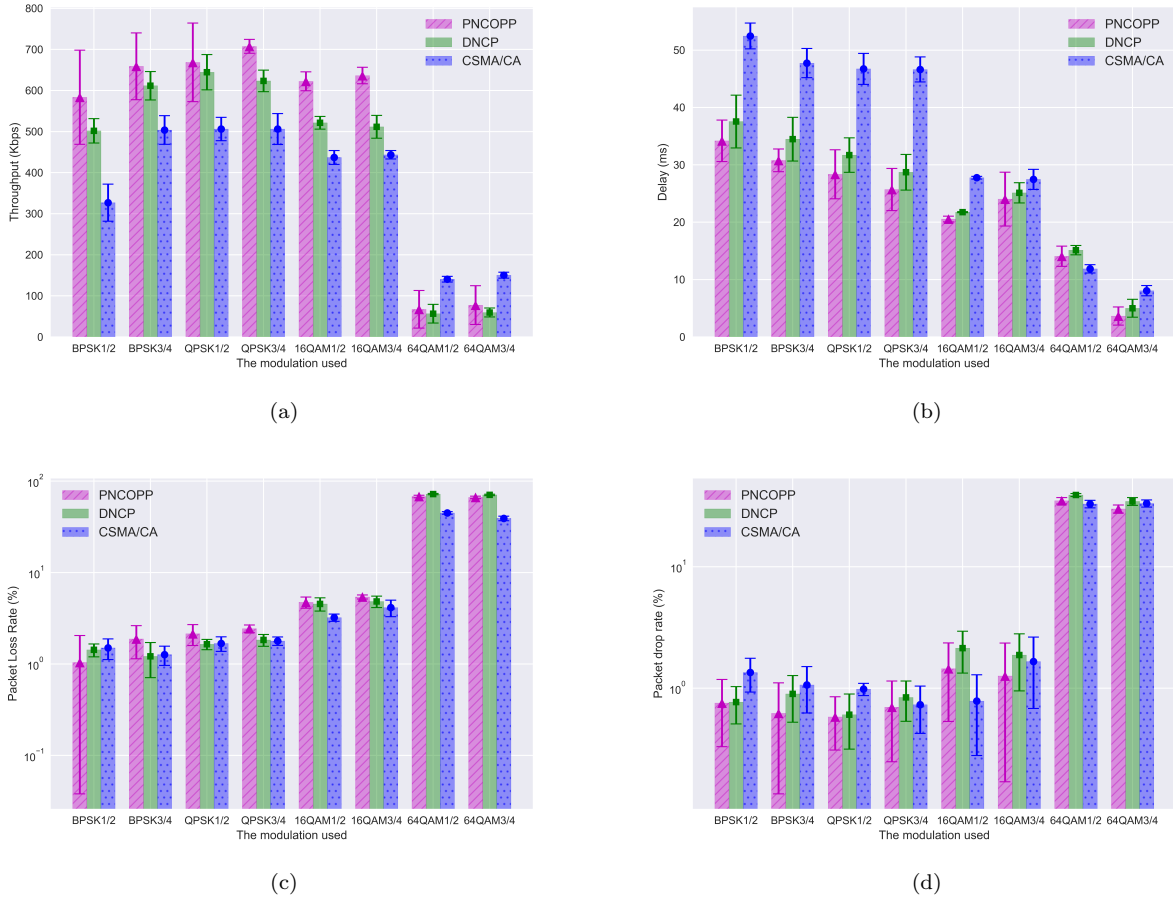

Figure 13: Results for the *TWRC* topology.

all the metrics. The reason is that the PNCOPP is particularly designed for the TWRC network (3 nodes only) and produces, therefore, the minimum possible control frames, the lowest delay, and the best throughput.

4.4. Results of the Full topology

In this section, we present the results of the DNCP, PNCOPP, and the CSMA/CA MAC protocols over the *Full* topology to see the hidden stations' effect on the TWRC network.

As we presented before, the most suitable modulation for the presented system is the QPSK3/4 modulation. Therefore, besides

the parameters shown in Table 4, we used the modulation QPSK3/4 and the sample rate $10MHz$.

For figures 14 (a), 14 (b), 14 (c), and 14 (d), the results represent the minimum (Min), average (Avg), and maximum (Max) metrics values of five experiments (with confidence interval 95%). Each experiment took 50 minutes, and every 10 minutes, the results values were taken to see the stability of the MAC protocols over time.

For all performance metrics, we can note that DNCP always outperforms the PNCOPP and conventional CSMA/CA MAC protocols, except for the packet's loss rate

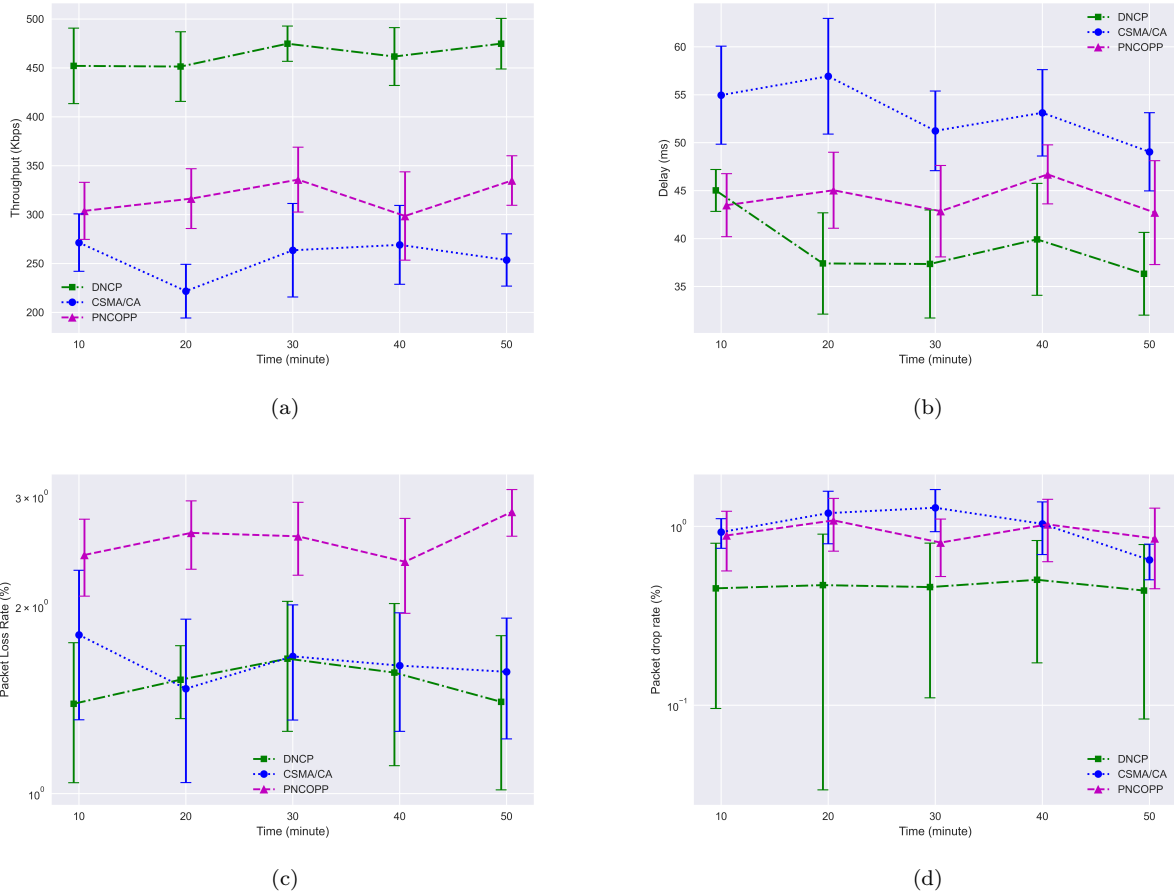

Figure 14: Results of the *Full* topology.

metric, where the results of the DNCP and CSMA/CA MAC protocols are almost identical.

It can be observed from this figure that the throughput gain of DNCP over CSMA/CA is about 1.82, which approaches the theoretical result of 2 as discussed in Section 1, and about 1.39 over PNCOPP.

Compared to the throughput obtained with the simple TWRC topology, in *full* topology, the throughput decreases slightly because of collisions or what we refer to as *destructive interference* caused by the channel contention, which becomes intense with the increasing node number. This ob-

servaion is particularly significant for the PNCOPP, which suffers from the hidden station issue since it is not designed to perform in large networks and does not use any control frame to reserve the channel, which makes it vulnerable to hidden terminal problems.

The error bars also show that the results of the DNCP MAC protocol are not very distracting, indicating our solution's stability.

In terms of delay, when it is an ordinary transmission, the DNCP will have the same behavior as the conventional CSMA/CA and PNCOPP and, therefore, achieves the

same delay. Though, when dealing with PNC opportunities, DNCP requires an additional exchange of control messages in order to coordinate the two transmissions simultaneously, then more delays. Also, the increased throughput achieved by DNCP allows more packets to enter the network, and consequently, packets may have to wait longer in the queue. However, this delay is compensated by using single access control for two transmissions simultaneously and using a new policy to avoid the *destructive interferences* caused by the hidden station, which explains the gain in delay provided by our DNCP protocol compared to CSMA/CA and to the PNCOPP which suffer from *destructive interferences* caused by the hidden stations.

The packet loss is minor and almost the same for the DNCP and CSMA/CA protocols. This is due to a robust physical layer using the *QPSK* modulation technique coupled with reliable hidden nodes management at the MAC layer, which considerably reduces packet losses caused by transmission errors or interference. Nevertheless, for the PNCOPP MAC protocol, which gives the worst performance in terms of packet loss rate due to its vulnerability to hidden terminal problems and *destructive interferences* as it does not include any control frame to reserve the channel prior to the data transmission.

4.5. Results of the Line topology

The *Line* topology is used to study the DNCP behavior when successive relaying nodes are added to the system.

It can be observed from Figure 15 that DNCP outperforms both the conventional CSMA/CA and the PNCOPP MAC protocol, with, respectively, an average throughput gain of 1.72 and 1.40. However, com-

pared to TWRC and full topologies, the overall performance slightly decreases because the additional relay processing may result in more end-to-end delays, which consequently reduces the number of transmitted packets. Nevertheless, considering a single PNC opportunity between nodes *A* and *F* considerably reduces the risk of collisions, loss, and drop of packets, which justifies the stability of these results compared to previous topologies. Moreover, as we consider static networks (because routing issues need to be considered in a network with mobility, which is beyond the scope of this paper), it is not likely to have link failure for DNCP, PNCOPP, and CSMA/CA protocols, which explains the fairly low values of the loss rates.

In order to assess the goodput of our proposal, we evaluated, for the three considered topologies, the overhead involved by the PNC orchestration. Results are depicted in Figure 16. For all scenarios, PNCOPP gives the best performance for the overhead compared to DNCP and CSMA/CA. Indeed, to exchange two packets in a PNC transmission, PNCOPP needs only four control frames (*RTS*, *CTS*, 2 *ACK*), while DNCP uses seven control frames (*RTS_{AB}*, *PNC_R_{AB}*, *PNC_C_{AB}*, *CST_{AB}*, *PNC_CONFIRM*, 2 *ACK*) and CSMA/CA uses 12 control frames (4 *RTS*, 4 *CTS*, 4 *ACK*), which explains these findings. However, for Full and Line topologies, the results of DNCP are close to those of PNCOPP as DNCP compensates the large number of control frames used by the increasing number of PNC opportunities it detects. It can also be explained by the new policy introduced by DNCP to avoid the hidden station problems and the consequent losses.

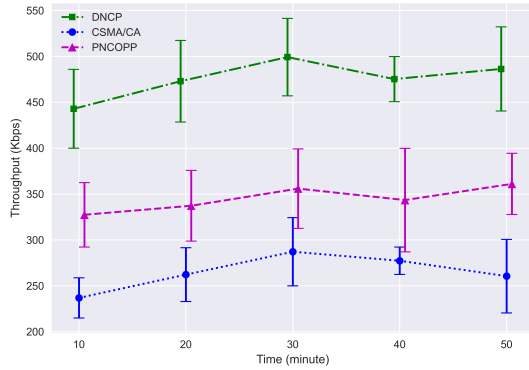

(a)

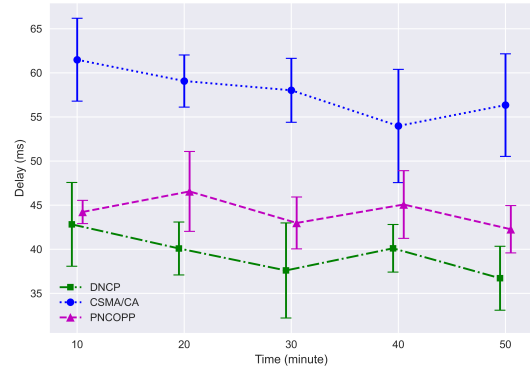

(b)

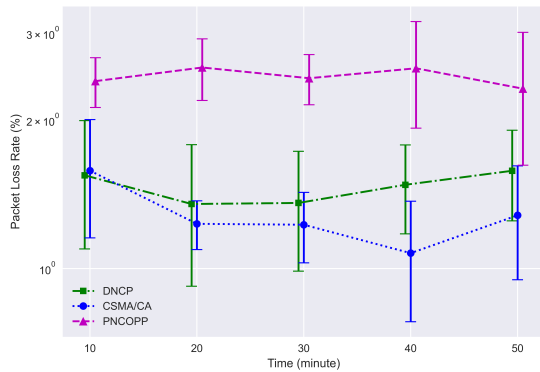

(c)

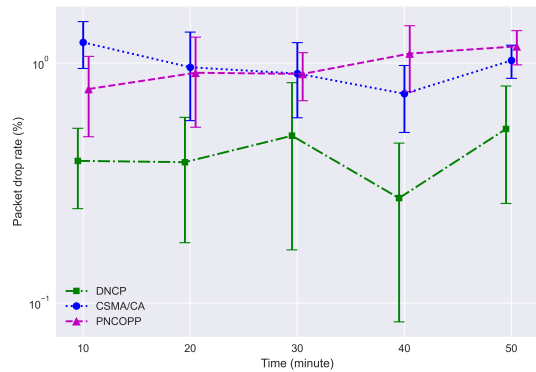

(d)

Figure 15: Results of the *Line* topology.

5. Conclusion

In this paper, we have proposed the Distributed physical-layer Network Coding MAC Protocol (DNCP), which extends the IEEE 802.11 MAC protocol to support PNC.

The basic idea of our proposal was to detect the opportunities of PNC by using conventional RTS/CTS frames and to coordinate the channel access between the concerned source nodes via a common relay node to carry simultaneous transmissions.

The focus of the proposed protocol is on compatibility with other conventional relaying schemes so that ordinary data transmis-

sions (not part of a PNC opportunity) still occur correctly. Several mechanisms were proposed to address such issues caused by the hidden node problem, such as NAV enhancement and ACK diversity, which has led to a reliable packet exchange that avoids destructive interference.

In order to have a practical solution, we addressed effective assumptions related to the hardware requirements and the network topology, and we carried out a real-world evaluation using an SDR-based testbed. The DNCP's performances are evaluated for the TWRC, Line, and Full topologies and are compared with the conventional

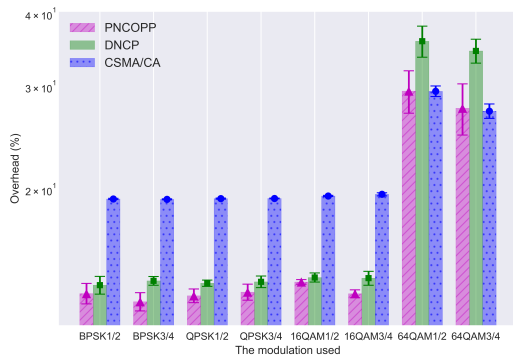

(a) TWRC topology

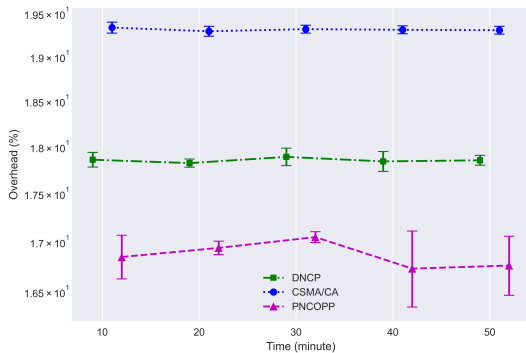

(b) Full topology

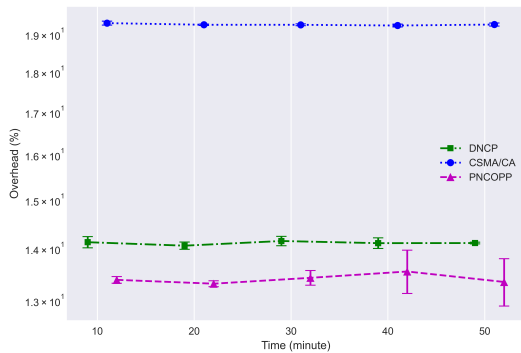

(c) Line topology

Figure 16: Overhead results.

CSMA/CA MAC and PNCOPP MAC protocols [11] using four metrics: the throughput, the delay, the packet loss rate, and the packet drop rate since these metrics are the most impacted by the PNC technique.

The experimentation results show that the proposed DNCP brings considerable throughput improvement in various scenarios while maintaining a similar trend to the packet loss results. It follows that DNCP is advantageous, particularly for throughput-sensitive applications of wireless networks.

A deeper analysis of the multi-relay line topology is worth investigating in the future. Moreover, as we considered, in this work, a static routing, we intend, in the future, to couple and adapt the PNC technique and the MAC level scheduling to have an opportunistic routing capable of directing the data packets on the paths that support the PNC opportunities.

References

- [1] S. Zhang, S. C. Liew, P. P. Lam, Hot topic: Physical-layer network coding, in: Proceedings of the 12th annual international conference on Mobile computing and networking, 2006, pp. 358–365.
- [2] E. Worlanyo, Network coding for wireless applications: A review (2016).
- [3] S. C. Liew, S. Zhang, L. Lu, Physical-layer network coding: Tutorial, survey, and beyond, *Physical Communication* 6 (2013) 4–42.
- [4] S. C. Liew, L. Lu, S. Zhang, A primer on physical-layer network coding, *Synthesis Lectures on Communication Networks* 8 (1) (2015) 1–218.
- [5] C. Fragouli, J.-Y. Le Boudec, J. Widmer, Network coding: an instant primer, *ACM SIGCOMM Computer Communication Review* 36 (1) (2006) 63–68.
- [6] S. Wang, Q. Song, X. Wang, A. Jamalipour, Distributed mac protocol supporting physical-layer network coding, *IEEE Transactions on Mobile Computing* 5 (12) (2013) 1023–1036.
- [7] L. Lu, S. C. Liew, Asynchronous physical-layer network coding, *IEEE Transactions on Wireless Communications* 11 (2) (2011) 819–831.
- [8] Y. Huang, S. Wang, Q. Song, L. Guo, A. Jamalipour, Synchronous physical-layer network coding: A feasibility study, *IEEE transac-*

- tions on wireless communications 12 (8) (2013) 4048–4057.
- [9] L. You, S. C. Liew, L. Lu, Reliable physical-layer network coding supporting real applications, *IEEE Transactions on Mobile Computing* 16 (8) (2016) 2334–2350.
- [10] I. C. S. L. M. S. Committee, et al., Wireless lan medium access control and physical layer specification, *IEEE 802.11 Standard* (1999).
- [11] H. Yomo, Y. Maeda, Distributed mac protocol for physical layer network coding, in: 2011 The 14th International Symposium on Wireless Personal Multimedia Communications (WPMC), 2011, pp. 1–5.
- [12] A. Argyriou, Mac protocol for wireless cooperative physical-layer network coding, in: 2012 IEEE Wireless Communications and Networking Conference (WCNC), 2012, pp. 1596–1601.
- [13] Q. Hoang, T. Xuan Nam, L.-T. Nguyen, Cross-layer design of bidirectional-traffic supported cooperative mac protocol, in: International Conference on Advanced Technologies for Communications, Vol. 2015, 2015, pp. 586–593.
- [14] W. Mao, X. Wang, A. Tang, H. Qian, Anc-era: Random access for analog network coding in wireless networks, *IEEE Transactions on Mobile Computing* 15 (01) (2016) 45–59.
- [15] Q. T. Hoang, Phy-mac cross-layer cooperative protocol supporting physical-layer network coding (2020).
- [16] J. He, S.-C. Liew, Building blocks of physical-layer network coding, *IEEE Transactions on Wireless Communications* 14 (5) (2015) 2711–2728.
- [17] Y. Huang, Q. Song, S. Wang, A. Jamalipour, Phase-level synchronization for physical-layer network coding, in: 2012 IEEE Global Communications Conference (GLOBECOM), 2012, pp. 4423–4428.
- [18] Y. Chen, D. Haley, Q. B. Nguyen, Frequency offset compensation in physical-layer network coding systems, in: 2013 Australian Communications Theory Workshop (AusCTW), 2013, pp. 146–151.
- [19] D. Kramarev, Practical physical layer network coding, Ph.D. thesis, Monash University (2016).
- [20] D. Kramarev, A. Sakzad, E. Viterbo, Implementation of a two-way relay network with compute-and-forward in gnu radio, *Transactions on Emerging Telecommunications Technologies* 27 (4) (2016) 484–493.
- [21] O. Hotescu, K. Jaffrès-Runser, A. Van Den Bossche, T. Val, Synchronizing tiny sensors with sisp: a convergence study, in: Proceedings of the 20th ACM International Conference on Modelling, Analysis and Simulation of Wireless and Mobile Systems, 2017, pp. 279–287.
- [22] L. Lu, L. You, Q. Yang, T. Wang, M. Zhang, S. Zhang, S. C. Liew, Real-time implementation of physical-layer network coding, in: Proceedings of the second workshop on Software radio implementation forum, 2013, pp. 71–76.
- [23] T. Hynes, D. Halls, J. Sykora, Hardware implementation of distributed learning algorithm for mapping selection for wireless physical layer network coding, in: 2015 IEEE International Conference on Communication Workshop (ICCW), IEEE, 2015, pp. 2127–2132.
- [24] Y. Tan, S. C. Liew, T. Huang, Mobile lattice-coded physical-layer network coding with practical channel alignment, *IEEE Transactions on Mobile Computing* 17 (8) (2018) 1908–1923.
- [25] R. Naves, G. Jakllari, H. Khalife, V. Conan, A.-L. Beylot, When analog meets digital: Source-encoded physical-layer network coding, *Pervasive and Mobile Computing* 58 (2019) 101021.
- [26] H. Wang, G. Wang, B. Li, Adaptive transmission combining physical-layer network coding and successive interference cancellation for two-way relay system, in: Communications, Signal Processing, and Systems: Proceedings of the 2017 International Conference on Communications, Signal Processing, and Systems, Springer, 2019, pp. 323–330.
- [27] J. Li, W. Chen, Z. Lin, B. Vucetic, Design of physical layer network coded ldpc code for a multiple-access relaying system, *IEEE communications letters* 17 (4) (2013) 749–752.
- [28] A. Salim, T. M. Duman, Exchange of correlated binary sources in two-way relay networks using ldpc codes, *IEEE Wireless Communications Letters* 6 (5) (2017) 594–597.
- [29] M. Gast, 802.11 wireless networks: the definitive guide, "O'Reilly Media, Inc.", 2005.
- [30] A. Van den Bossche, T. Val, R. Dalce, Sisp: a lightweight synchronization protocol for wireless sensor networks, in: ETFA2011, 2011, pp.

- 1–4.
- [31] G. FSF, Gnu radio - gnu fsf project, <https://www.gnuradio.org>.
- [32] E. Inc, Universal software radio peripheral, <https://www.ettus.com>.
- [33] A. Massouri, L. Cardoso, B. Guillon, F. Hutu, G. Villemaud, T. Risset, J.-M. Gorce, Cortextlab: An open fpga-based facility for testing sdr & cognitive radio networks in a reproducible environment, in: 2014 IEEE Conference on Computer Communications Workshops (INFOCOM WKSHPs), 2014, pp. 103–104. doi:10.1109/INFOCOMW.2014.6849176.
- [34] B. Bloessl, M. Segata, C. Sommer, F. Dressler, An ieee 802.11 a/g/p ofdm receiver for gnu radio, in: Proceedings of the second workshop on Software radio implementation forum, 2013, pp. 9–16.
- [35] B. Bloessl, M. Segata, C. Sommer, F. Dressler, gr-ieee802-11 : Ieee 802.11 a/g/p ofdm receiver for gnu radio (2013).
URL <https://github.com/bastibl/gr-ieee802-11>
- [36] A. Gomes, gr-macprotocols: Gnu radio csma/ca mac protocol (2018).
URL <https://github.com/gom3sa/gr-macprotocols>
- [37] P. Djukic, P. Mohapatra, Soft-tdmac: A software tdma-based mac over commodity 802.11 hardware, in: IEEE INFOCOM 2009, IEEE, 2009, pp. 1836–1844.
- [38] H. Rahul, H. Hassanieh, D. Katabi, Sourcesync: A distributed wireless architecture for exploiting sender diversity, ACM SIGCOMM Computer Communication Review 40 (4) (2010) 171–182.
- [39] I. Palamà, G. Santaromita, Y. Lizarribar, L. M. Monteforte, S. Bartoletti, D. Giustiniano, G. Bianchi, N. B. Melazzi, From experiments to insights: A journey in 5g new radio localization, in: 2023 21st Mediterranean Communication and Computer Networking Conference (MedComNet), IEEE, 2023, pp. 74–82.
- [40] Ettus, Ettus octoclock, <https://www.ettus.com/all-products/octoclock-g/>.
- [41] Y. G. Li, G. L. Stuber, Orthogonal frequency division multiplexing for wireless communications, Springer Science & Business Media, 2006.
- [42] L. Lu, T. Wang, S. C. Liew, S. Zhang, Implementation of physical-layer network coding, Physical Communication 6 (2013) 74–87.
- [43] K. H. Ngo, Q. T. Nguyen, Implementation of network coding scheme in universal software radio peripheral, in: ICDV: The 5th International Conference on Integrated Circuits, Design, and Verification, 2014.
- [44] T. T. T. Quynh, T. V. Khoa, L. Van Nguyen, N. Linh-Trung, Network coding with multimedia transmission: A software-defined-radio based implementation, in: 2019 3rd International Conference on Recent Advances in Signal Processing, Telecommunications & Computing (SigTelCom), IEEE, 2019, pp. 109–113.
- [45] T. T. T. Quynh, N. K. Hoang, N. Van Ly, N. L. Trung, N. Q. Tuan, E. Bastug, S. Azarian, V. N. Q. Bao, T. X. Nam, M. Debbah, et al., Network coding with multimedia transmission and cognitive networking: An implementation based on software-defined radio, REV Journal on Electronics and Communications 10 (3-4) (2021) 72–84.
- [46] N. K. Hoang, Sdr implementation of ofdm-based physical layer network coding, Ph.D. thesis, VIETNAM NATIONAL UNIVERSITY, HANOI UNIVERSITY OF ENGINEERING AND TECHNOLOGY (2014).
- [47] M. Aissaoui, C. Houaidia, A. van Den Bossche, T. Val, L. A. Saidane, Physical-layer network coding: A heterogeneous software-defined-radio based implementation, in: 2022 IEEE 11th IFIP International Conference on Performance Evaluation and Modeling in Wireless and Wired Networks (PEMWN), 2022, pp. 1–6.
- [48] B. Bloessl, A. Puschmann, C. Sommer, F. Dressler, Timings matter: Standard compliant ieee 802.11 channel access for a fully software-based sdr architecture, ACM SIGMOBILE Mobile Computing and Communications Review 18 (3) (2015) 81–90.
- [49] M. Aissaoui, C. Houaidia, A. Van Den Bossche, T. Val, L. A. Saidane, A new taxonomy of physical-layer network coding techniques in two way relay channel model with single antenna, in: 2021 10th IFIP/IEEE International Conference on Performance Evaluation and Modeling in Wireless and Wired Networks (PEMWN), 2021, pp. 1–6.
- [50] O. A. Surti, J. Gomes, Impact of high speed

- modulation technique on wireless network 4 (2015).
- [51] J. S. Yeom, K. Ko, H. Jin, B. C. Jung, Performance analysis of physical-layer network coding with qpsk modulation in wireless iot networks, *ICT Express* 8 (3) (2022) 419–423.
 - [52] S. Wang, Q. Song, L. Guo, A. Jamalipour, Constellation mapping for physical-layer network coding with m-qam modulation, in: 2012 IEEE Global Communications Conference (GLOBECOM), 2012, pp. 4429–4434.
 - [53] F. Wang, Q. Song, S. Wang, L. Guo, Rate and power adaptation for physical-layer network coding with m-qam modulation, in: 2014 IEEE International Conference on Communications (ICC), 2014, pp. 5508–5513.
 - [54] H. Haboobi, M. R. Kadhum, Impact study and evaluation of higher modulation schemes on physical layer of upcoming wireless mobile networks, *International Journal of Advanced Computer Science and Applications* 10 (5) (2019).
 - [55] H. Otsuka, R. Tian, K. Senda, Transmission performance of an ofdm-based higher-order modulation scheme in multipath fading channels, *Journal of Sensor and Actuator Networks* 8 (2) (2019) 19.
 - [56] P. K. Singya, P. Shaik, N. Kumar, V. Bhatia, M.-S. Alouini, A survey on design and performance of higher-order qam constellations, *arXiv preprint arXiv:2004.14708* (2020).